

Item	Description	Part No.	Parts motor for MINIDOS			
			A 3	A 5	A 8 + A 14	A 24 + A 40
			23067	23097	23228	23258
1	Stator	21216	1	—	1	—
		21221	—	1	—	1
2	Pump base	29457	1	1	1	1
3	Ball bearing compensating disc	84141	1	1	1	1
4	Ball bearing	86049	2	2	2	2
5	Rotor	21215	1	—	1	—
		21220	—	1	—	1
6	Impeller mounting	21218	1	1	1	1
7	Impeller	21217	1	1	1	1
8	Cover plate	29960	1	1	1	1
9	Pull rod	21219	3	3	3	3
10	Circlip	84134	1	1	1	1
11	Circlip	84084	1	1	1	1
12	Worm shaft	11378	1	1	—	—
		11376	—	—	1	—
		19157	—	—	—	—
13	Locking sleeve	83414	1	1	1	1
14	Spring washer	84171	3	3	3	3

Minidos A 3 ... A 24

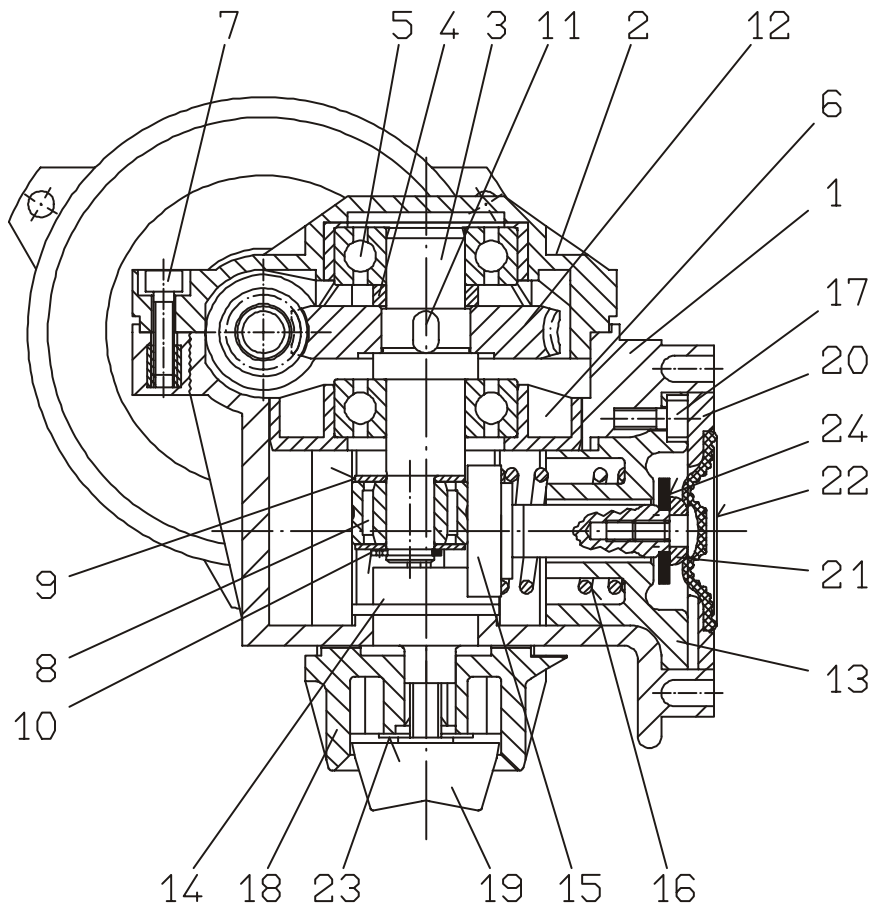

Minidos A 40

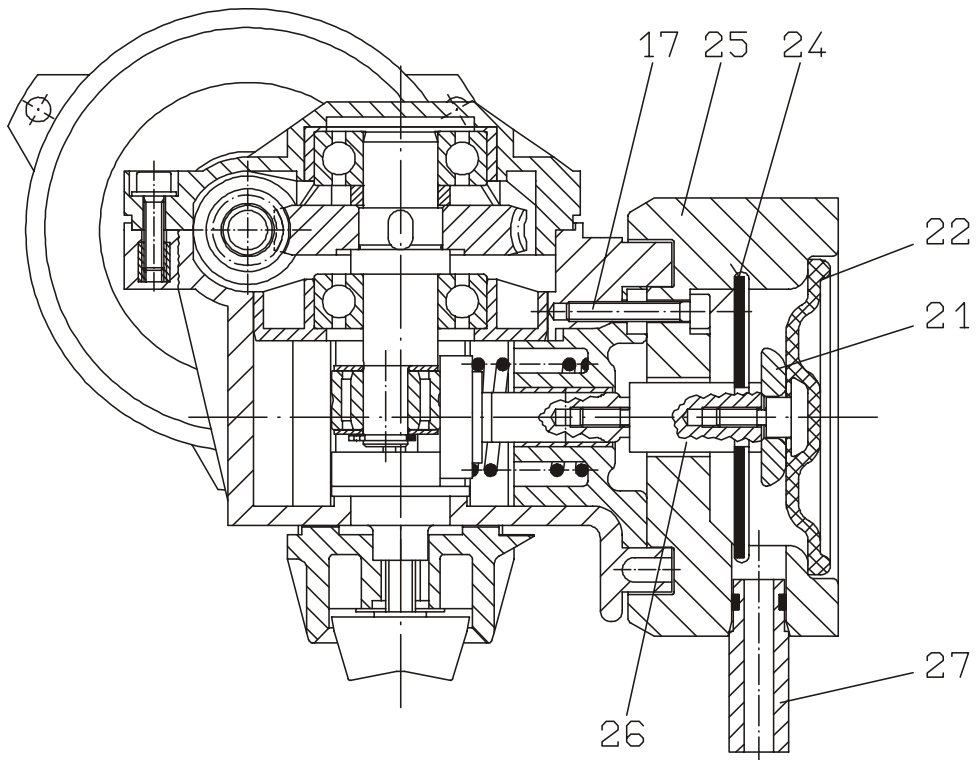

Item	Description	Material	Part No.	A 3+A 5 29969	A 8 29970	A 14 29971	A 24 29972	A 40 35129
1	Gearbox casing	Plastic	29456	1	1	1	1	–
	Gearbox casing	Plastic	35128	–	–	–	–	1
2	Casing cover	Plastic	29458	1	1	1	1	1
3	Drive shaft	Steel	21203	1	1	1	1	1
4	Spacer	Steel	21210	1	1	1	1	1
5	Ball bearing	Steel	86006	2	2	2	2	2
6	Bearing insert	Brass	29964	1	1	1	1	1
7	Socket head cap screw	Steel	83409	4	4	4	4	4
8	Needle Bearing	Steel	86097	1	1	1	1	1
9	Sealing washer	Steel	21209	2	2	2	2	2
10	Circlip	Spring steel	84135	1	1	1	1	1
11	Key way	Steel	83406	1	1	1	1	1
12	Worm gear	Bronze	18014	1	–	–	–	–
	Worm gear	Bronze	18160	–	1	1	–	–
	Worm gear	Bronze	21188	–	–	–	1	1
13	Guide bush	Plastic/bz	29460	1	1	1	1	1
14	Adjusting eccentric	Plastic	29763	1	1	1	1	1
15	Diaphragm rod	Steel	21204	1	1	1	1	1
16	Compression spring	Spring steel	18027	1	1	1	1	1
17	Lens head Screw	Steel	83653	4	4	4	4	–
	Lens head Screw	A2	83891	–	–	–	–	4
18	Adjusting knob	Plastic	29764	1	1	1	1	1
19	Wing screw	Plastic/steel	83661	1	1	1	1	1
20	Diaphragm insert ø 38	Plastic	29461	1	1	–	–	–
	Diaphragm insert ø 52	Plastic	29462	–	–	1	1	–
21	Support plate for ø 38 Viton	Brass	10205	1	1	–	–	–
	Support plate for ø 38 PTFE-coated	Brass	23892	1	1	–	–	–
	Support plate for ø 64 PTFE-coated	Brass	28977	–	–	–	–	1
22*	Diaphragm ø 38 Viton	Viton	81252	1	1	–	–	–
	Diaphragm ø 38 PTFE-coated	EPDM	81463	1	1	–	–	–
	Diaphragm ø 52 PTFE-coated	EPDM	81464	–	–	1	1	–
	Diaphragm ø 64 PTFE-coated	EPDM	81465	–	–	–	–	1
23	Tension disc	Stainless steel	84179	1	1	1	1	1
24	Deflector plate	Hypalon	81260	1	1	1	1	–
	Deflector plate	Hypalon	22056	–	–	–	–	1
25	Spacer	Plastic	35126	–	–	–	–	1
26	Extension	Stainless steel	35127	–	–	–	–	1
27	Leakage pipe	Plastic/Viton	25174	–	–	–	–	1

* Alternative, PTFE-coated diaphragm as standard

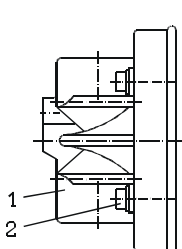

Item	Qty	Description	Material	Metering head assembly								
				A3...8	A14...24	A40	A3...8	A14...24	A3...8	A14...24	A40	
				PVC			PVDF			1.4571		
				23810	23811	23909	28119	23178	23813	23814	23911	
1	1	Diaph. housing		21222	22399	18113	28118	28689	21612	21613	23912	
2	4	Screw	A2	83409	83409	83110	83409	83409	83622	83622	83110	
3	4	Washer	A2	–	–	84160	–	–	–	–	84160	

DN 4 Valves for A3...A24

MINIDOS A

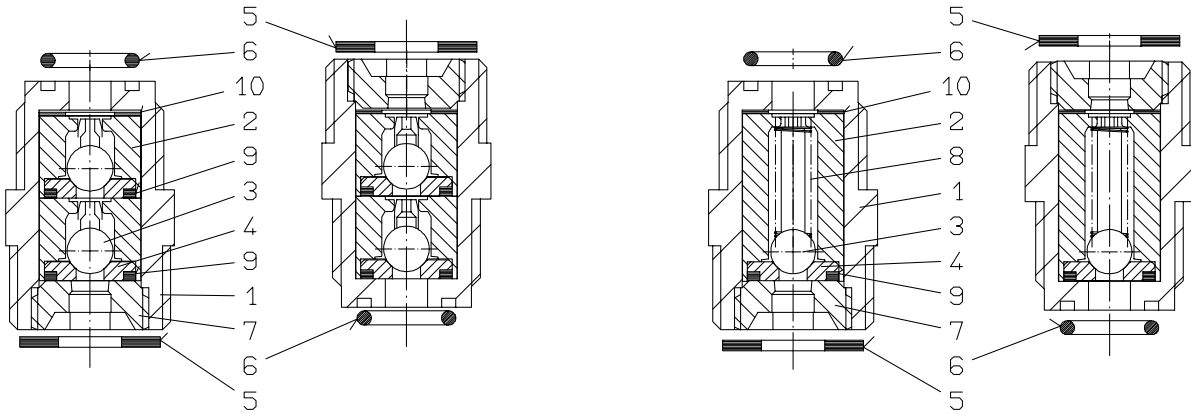

Item	Description	Material	Part No.	Double-ball valve			Spring-loaded valve		
				PVC	PVDF	1.4571	PVC	PVDF	1.4571
1	Valve body	PVC	20845	1	–	–	1	–	–
	Valve body	PVDF	28108	–	1	–	–	1	–
	Valve body	1.4571	19289	–	–	1	–	–	1
2	Ball guide	PVC	19294	2	–	–	–	–	–
	Ball guide	PVDF	28109	–	2	–	–	–	–
	Ball guide	1.4571	19293	–	–	2	–	–	–
	Ball guide	PVC	24066	–	–	–	1	–	–
	Ball guide	PVDF	29386	–	–	–	–	1	–
	Ball guide	1.4571	24067	–	–	–	–	–	1
3	Valve ball ø 6.5	Glass	29778	2	2	–	1	1	–
	Valve ball ø 6.5	1.4401	18044	–	–	2	–	–	1
4	Valve seat	PVDF	81460	2	2	2	1	1	1
5	Gasket	Viton	81371	1	–	–	1	–	–
	Gasket	PTFE	81677	–	–	1	–	–	1
	Gasket	PTFE	81580	–	1	–	–	1	–
6	O-ring	Viton	81384	1	–	–	1	–	–
	O-ring	PTFE	80617	–	1	1	–	1	1
7	Plug	PVC	19299	1	–	–	1	–	–
	Plug	PVDF	28110	–	1	–	–	1	–
	Plug	1.4571	24031	–	–	1	–	–	1
8	Valve spring	Hastelloy	25081	–	–	–	1	1	1
9	O-ring	Viton	80013	2	–	–	1	–	–
	O-ring	PTFE	80627	–	2	2	–	1	1
10	Gasket	Viton	81526	1	–	–	1	–	–
	Gasket	PTFE	81585	–	1	1	–	1	1
Suction valve assembly				20890	28111	24029	25087	29385	25089
Discharge valve assembly				20891	28112	24030	25088	29384	25090

DN 6 Valves for A40

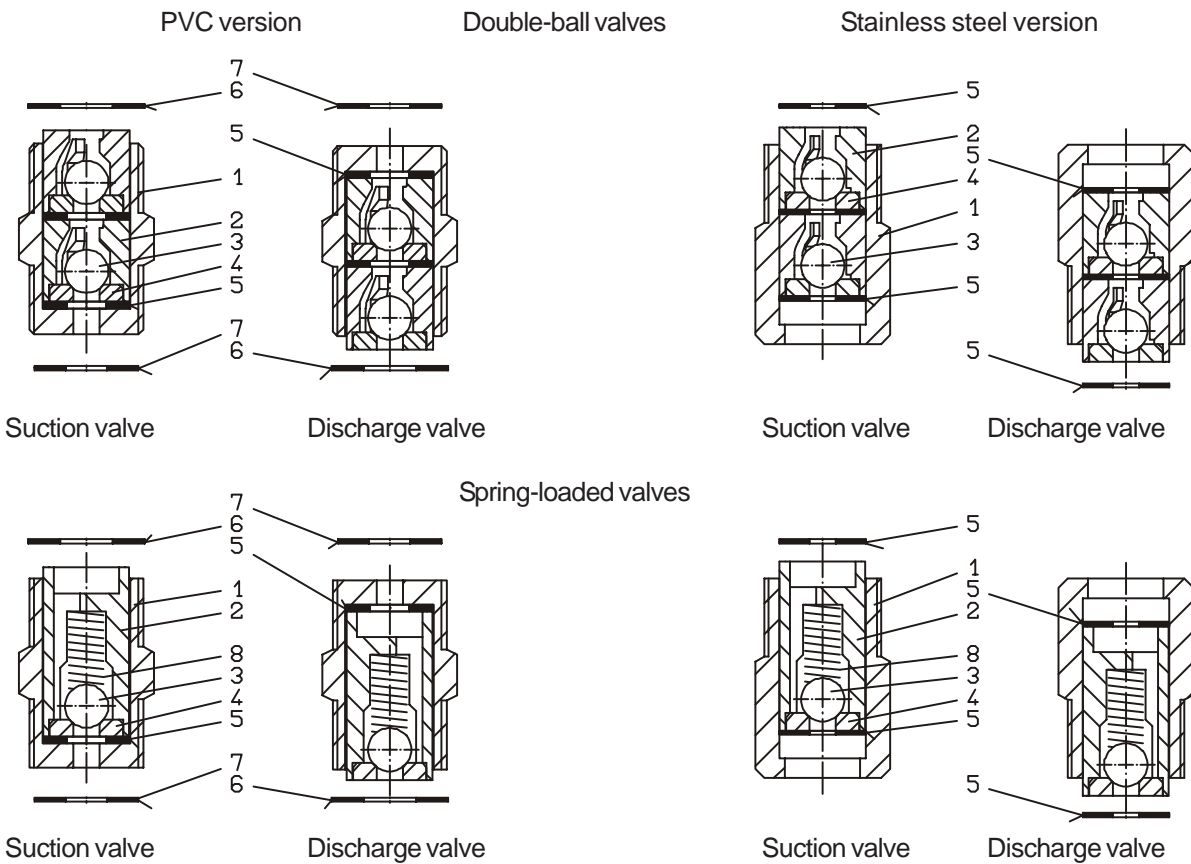

Item	Description	Part No	Material	Double-ball valve			Spring-loaded valve		
				PVC		1.4571	PVC		1.4571
				Hypalon	Viton	AF	Hypalon	Viton	AF
1	Valve housing	18189	PVC	1	1	–	1	1	–
		19601	1.4571	–	–	1	–	–	1
2	Ball guide	82405	PVC	2	2	–	–	–	–
		82102	1.4581	–	–	2	–	–	–
		23412	PVC	–	–	–	1	1	–
		25169	1.4571	–	–	–	–	–	1
3	Valve ball	10017	Glass	2	2	–	1	1	–
		10136	1.4401	–	–	2	–	–	1
4	Valve seat	82406	PVC	2	2	–	1	1	–
		82103	1.4571	–	–	2	–	–	1
5	Gasket	81037	Hypalon	2	–	–	1	–	–
		81138	Viton	–	2	–	–	1	–
		81625	AF	–	–	3	–	–	2
6	Gasket	81033	Hypalon	1	–	–	1	–	–
		81285	Viton	–	1	–	–	1	–
7	Gasket	81041	Hypalon	1	–	–	1	–	–
		81141	Viton	–	1	–	–	1	–
8	Valve spring	25082	Hastelloy	–	–	–	1	1	1
Suction valve assembly				18187	18185	26967	25161	25162	28775
Discharge valve assembly				18188	18186	26968	27516	27517	28776

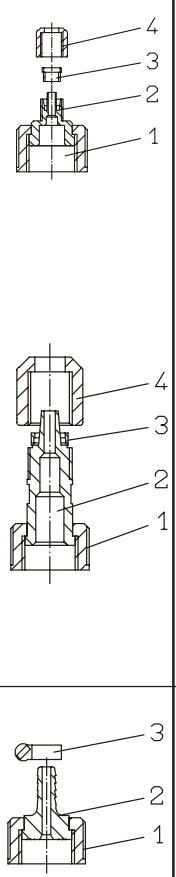
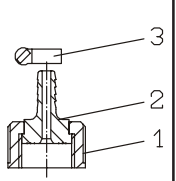
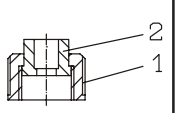
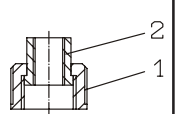
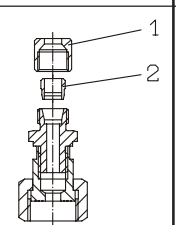
	Connect. Type	Material	Size	Connection assy Part Number	Item	Spare Parts	
						Description	Part No.
	A	PVC	4/6	20975	1	Union nut	88116
					2	Connection	88012
					3	Clamping ring	88003
					4	Union nut	88004
			6/8	25176	1	Union nut	82087
					2	Connection	31370
					4	Union nut	19397
					1	Union nut	88116
			6/9	34925	2	Connection	88199
					3	Clamping ring	34762
					4	Union nut	34696
					1	Union nut	82087
		6/12	19180	2	Connection	18094	
				3	Clamping ring	10178	
				4	Union nut	82139	
				PVDF	4/6	29387	1
2	Connection	88028					
3	Clamping ring	88003					
4	Union nut	88004					
6/12	28124		1	Union nut	28120		
			2	Connection	28121		
			3	Clamping ring	10178		
			4	Union nut	28122		
	B	PVC	6/12	23092	1	Union nut	82087
					2	Tubing connection	18042
					3	Hose clamp	82398
		1.4571	6/12	23093	1	Union nut	19303
					2	Tubing connection	18045
					3	Tubing connection	82398
	C	PVC	10	23087	1	Union nut	82087
			2	Cemented conn.	82014		
		12	23089	1	Union nut	82087	
				2	Cemented conn.	82013	
	D	PVC	G 1/4	23088	1	Union nut	82087
					2	Threaded conn.	82185
		PVDF	G 1/4	29179	1	Union nut	28120
					2	Threaded conn.	28292
		1.4571	G 1/4	22999	1	Union nut	19303
					2	Threaded conn.	82186
	E	1.4571	10	23090	1	Union nut	88038
					2	Olive	88039
		12	23091	1	Union nut	88040	
				2	Olive	88041	

Connection for A40

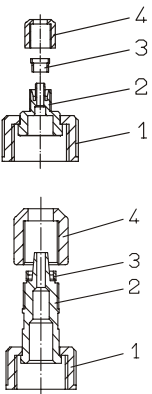
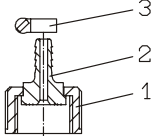
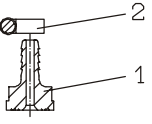
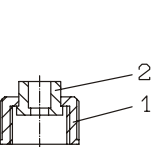
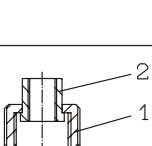
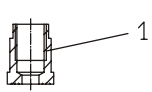
	Connection Type	Material	Size	Connection assy Part Number	Item	Spare parts	
						Description	Part-No.
	A	PVC	6/12	19175	1	Union nut	82156
					2	Tubing connection	18094
					3	Olive	10178
					4	Union nut	82139
			6/9	34926	1	Union nut	82156
					2	Tubing connection	88199
					3	Olive	34762
					4	Union nut	34696
	B	PVC	ø 6/12	23342	1	Union nut	82156
					2	Hose socket	18042
					3	Hose clamp	82398
	B1	1.4571	ø 6/12	23426	1	Hose socket	18268
					2	Hose clamp	82398
	C	PVC	ø 10	25167	1	Union nut	82156
			2		Cemented conn.	82014	
			ø 12	27518	1	Union nut	82156
			2		Cemented conn.	82013	
			ø 16	25625	1	Union nut	23685
			2		Cemented conn.	22508	
	D	PVC	G 1/4	25165	1	Union nut	82156
					2	Threaded Connection	82185
	D1	1.4571	G 1/4	82105	1	Threaded Connection	82105